

# Je m'appelle . . .



Mon nom est

---

---

---

Ma signature

[HTTPS://WWW.ONESCHOOLROOM.CA/HOW-TO-MAKE-A-SIGNATURE/](https://www.oneschoolroom.ca/how-to-make-a-signature/)

# Comment ça va?



ÇA VA TRÈS BIEN

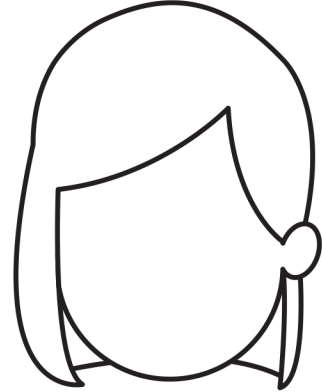

ÇA VA BIEN

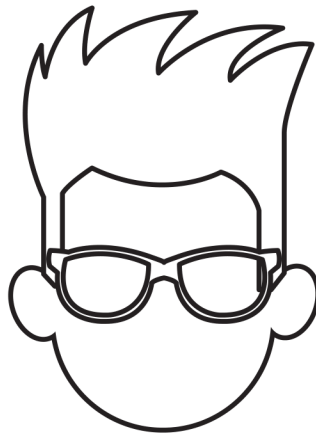

ÇA VA



ÇA VA MAL

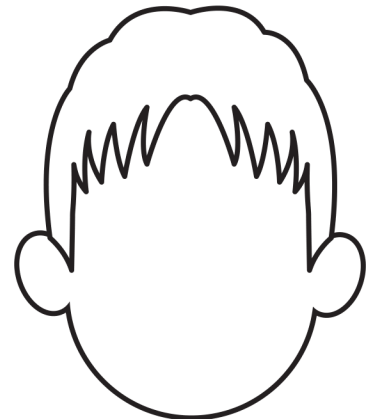

ÇA VA TRÈS MAL



# Les nombres

|        |       |      |      |
|--------|-------|------|------|
| QUATRE | DOUZE | UN   | NEUF |
| TROIS  | HUIT  | SIX  | CINQ |
| SEPT   | ONZE  | DEUX | DIX  |

|                            |                            |                            |
|----------------------------|----------------------------|----------------------------|
| 1<br><input type="text"/>  | 2<br><input type="text"/>  | 3<br><input type="text"/>  |
| 4<br><input type="text"/>  | 5<br><input type="text"/>  | 6<br><input type="text"/>  |
| 7<br><input type="text"/>  | 8<br><input type="text"/>  | 9<br><input type="text"/>  |
| 10<br><input type="text"/> | 11<br><input type="text"/> | 12<br><input type="text"/> |

# Combien de petits gâteaux?

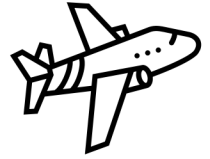

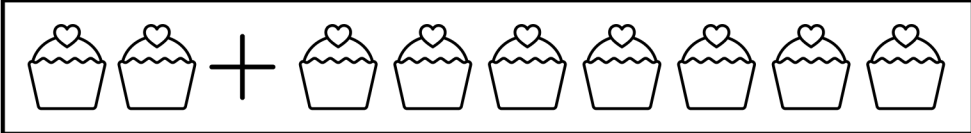
1  = \_\_\_\_\_

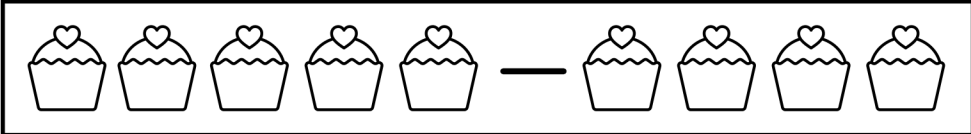
2  = \_\_\_\_\_

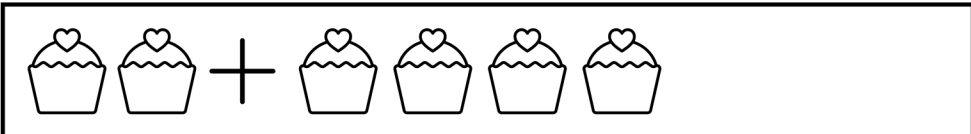
3  = \_\_\_\_\_

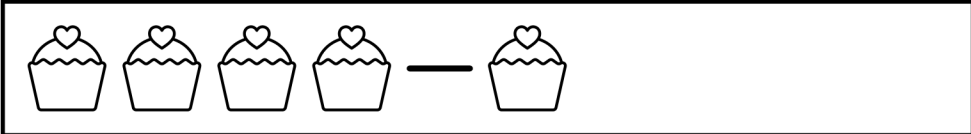
4  = \_\_\_\_\_

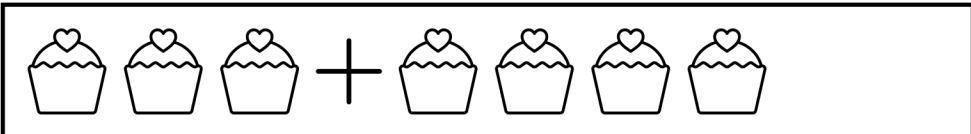
5  = \_\_\_\_\_

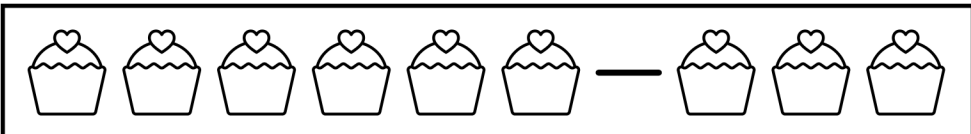
6  = \_\_\_\_\_

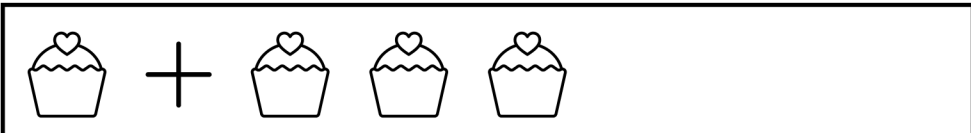
7  = \_\_\_\_\_

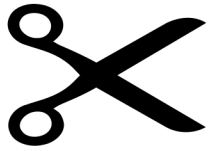

# Les mois de l'année



mars

juin

avril

décembre

septembre

novembre

janvier

octobre

juillet

février

mai

août

# Les couleurs



jaune  
bleu  
noir

vert  
rouge  
orange

blanc  
rose  
gris

violet



\_\_\_\_\_



\_\_\_\_\_



\_\_\_\_\_

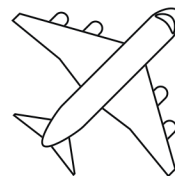

\_\_\_\_\_



\_\_\_\_\_

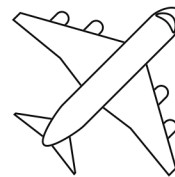

\_\_\_\_\_



\_\_\_\_\_

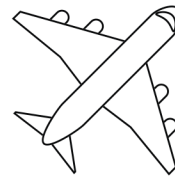

\_\_\_\_\_



\_\_\_\_\_

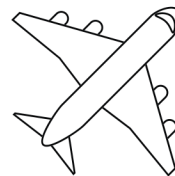

**brun**

**marron**



\_\_\_\_\_

**oneschoolroom.ca**



# Le ver vert

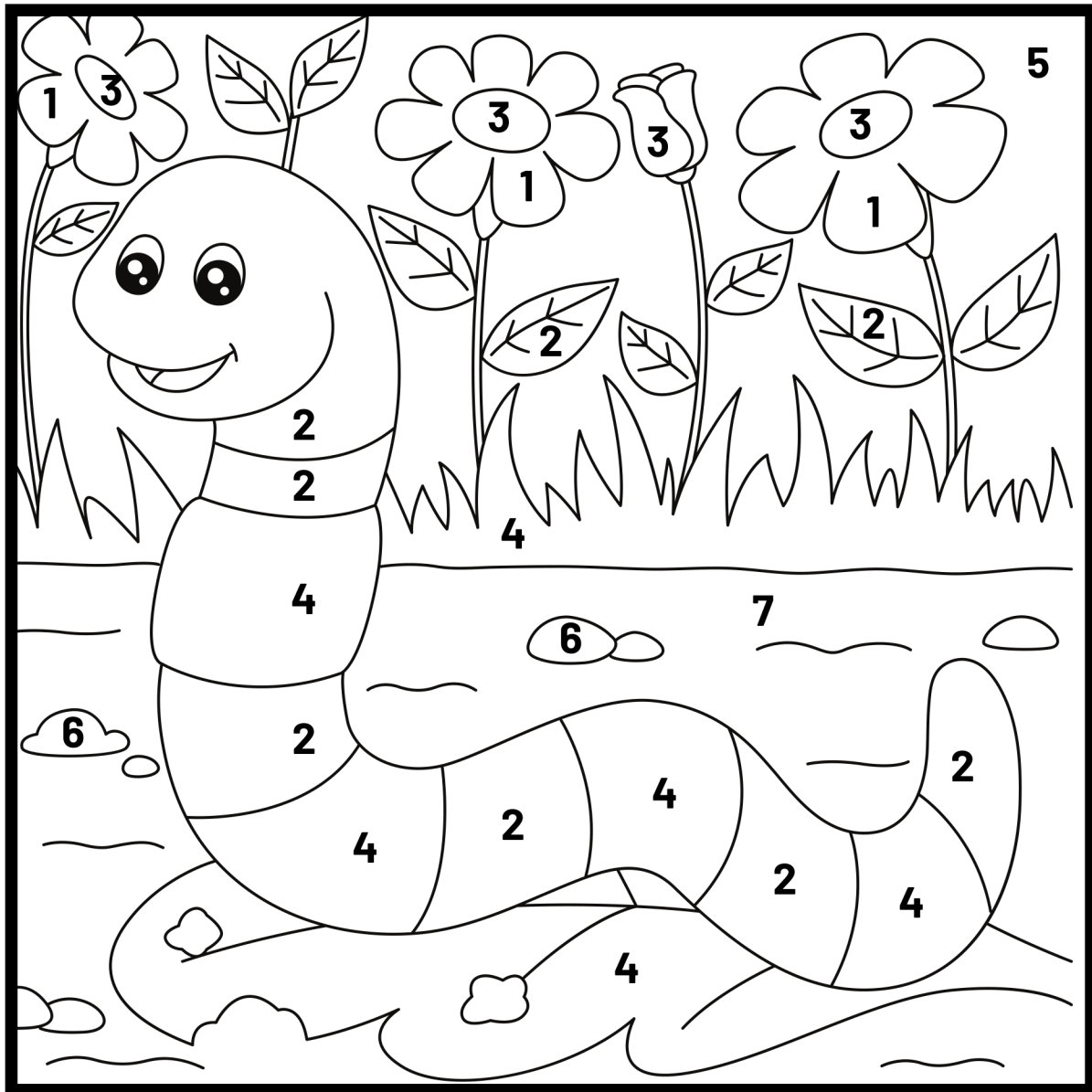

1. rouge

2. vert pâle

3. jaune

4. vert foncé

5. bleu

6. gris

7. brun

Je m'appelle \_\_\_\_\_



## Les nombres 11-31

|    |    |    |    |    |
|----|----|----|----|----|
| 11 | 12 | 13 | 14 | 15 |
|    |    |    |    |    |
| 16 | 17 | 18 | 19 | 20 |
|    |    |    |    |    |

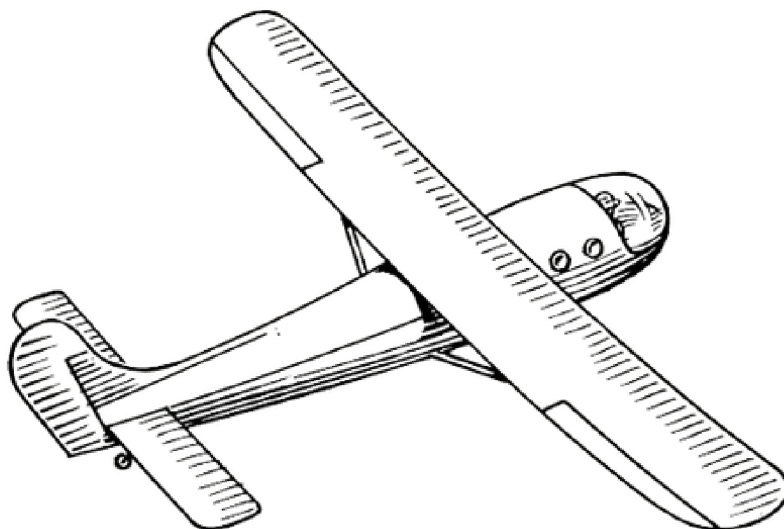



Je m'appelle \_\_\_\_\_



## Les nombres 11-31

|    |    |    |    |    |
|----|----|----|----|----|
| 21 | 22 | 23 | 24 | 25 |
|    |    |    |    |    |
| 26 | 27 | 28 | 29 | 30 |
|    |    |    |    |    |

|    |
|----|
| 31 |
|    |

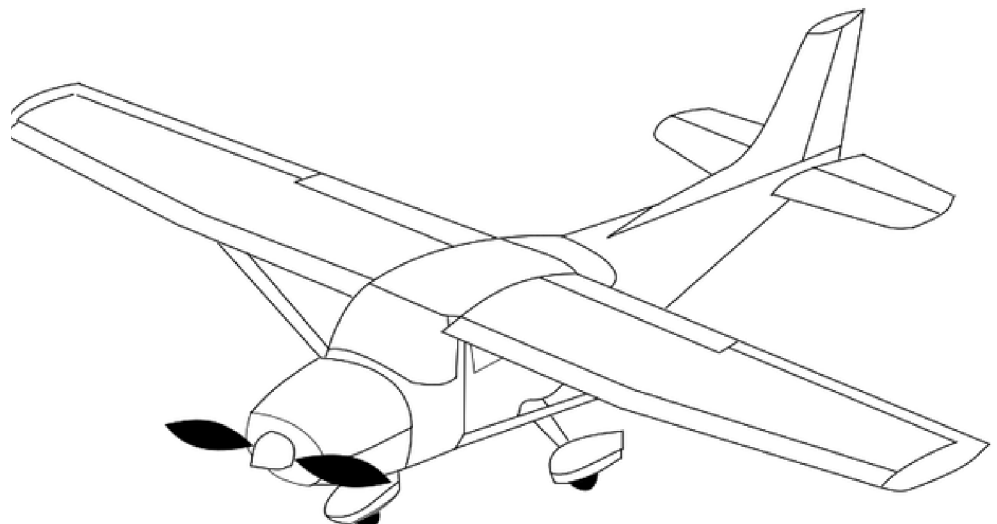



# Quelle est la date de ton anniversaire?

Mon anniversaire est le \_\_\_\_\_.